

REC'D DEC 18 1963

PB 181510
Price \$0.75

**SUMMARY OF INVESTIGATION OF MIDSHIP
BENDING MOMENTS EXPERIENCED BY
MODELS IN EXTREME REGULAR WAVES**

SSC-157

By

JOHN F. DALZEL

SHIP STRUCTURE COMMITTEE

Distributed by

**U.S. DEPARTMENT OF COMMERCE
OFFICE OF TECHNICAL SERVICES
WASHINGTON, D.C. 20230**

SSC-157

Final Report
of
Project SR-157
"Model in Extreme Waves"

to the
Ship Structure Committee

SUMMARY OF INVESTIGATION OF MIDSHIP BENDING MOMENTS
EXPERIENCED BY MODELS IN EXTREME REGULAR WAVES

by

John F. Dalzell
Stevens Institute of Technology

under

Department of the Navy
Bureau of Ships Contract NObs-88509

Washington, D. C.
U. S. Department of Commerce, Office of Technical Services

December 18, 1963

ABSTRACT

This report summarizes experimental research to investigate the possibility of a physical upper limit on midship bending moments being reached in regular waves of height significantly less than the theoretical upper limit of stability for progressive waves ($h/\lambda = 1/7$).

The experiments included variation of ship type, of distribution of loading and of freeboard as model parameters. The ship types investigated were a modern cargo vessel, a large tanker, and a modern destroyer. Each model was tested at various speeds in regular head and following waves of several different lengths and of a wide range of heights.

No significant upper limit of bending moment was found. However, the study establishes more firmly the grossly linear dependence of midship bending moment on wave height, even for extreme wave heights which may be encountered in service. These findings strengthened the case for determining design wave bending moments on the basis of statistical analyses of ocean waves and/or resulting bending moments.

CONTENTS

	<u>Page</u>
Introduction	1
Models and Techniques	1
Test Program	2
Data Reduction	4
Differences between Models	5
Trends of Bending Moments with Wave Steepness	7
Conclusions	10
Recommendations	11
References	11
Nomenclature	12

INTRODUCTION

Knowledge for design purposes of extreme wave bending moments on ship hulls in irregular storm seas is restricted to a relatively limited number of full scale ship observations. Efforts are currently being made toward determining design wave bending moments on the basis of statistical analyses of full scale and model data, an approach which requires considerable expenditure of time and funds.

A possible alternate approach was detailed in Ref. 1. This approach involves the use of models in very steep tank waves to determine if a physical upper limit on wave bending moments exists. An abbreviated pilot study employing this approach was conducted, and the results (reported in Ref. 1) indicated that limiting bending moments might be reached in regular waves of a height significantly less than the theoretical upper limit of stability for progressive waves.

The present investigation was initiated to see if the indications cited in the pilot study would apply more generally. The program included a broad variation of wave lengths, wave heights, and ship types, and included investigations of the effects of radical alterations of freeboard and weight distributions in one ship type. A moderate variation of model speed in head and following waves was also included in the program.

The methods used and the results obtained in this study are contained in Refs. 2 and 3. This report constitutes a summary of the material in those references.

MODELS AND TECHNIQUES

A relatively full account of test technique is contained in Refs. 2 and 3. The general methods followed those developed at the Davidson Laboratory and elsewhere over the last ten years. All test work was conducted in DL Tank No. 3 (300' x 12' x 6') in which only the head and following wave cases are possible. The significant difference between the present and the past experimental work was in the steepness of the waves employed.

Figure 1 illustrates the severity of the test conditions. The pictures are selected frames from two motion picture sequences. Each column of pictures is from the same sequence and

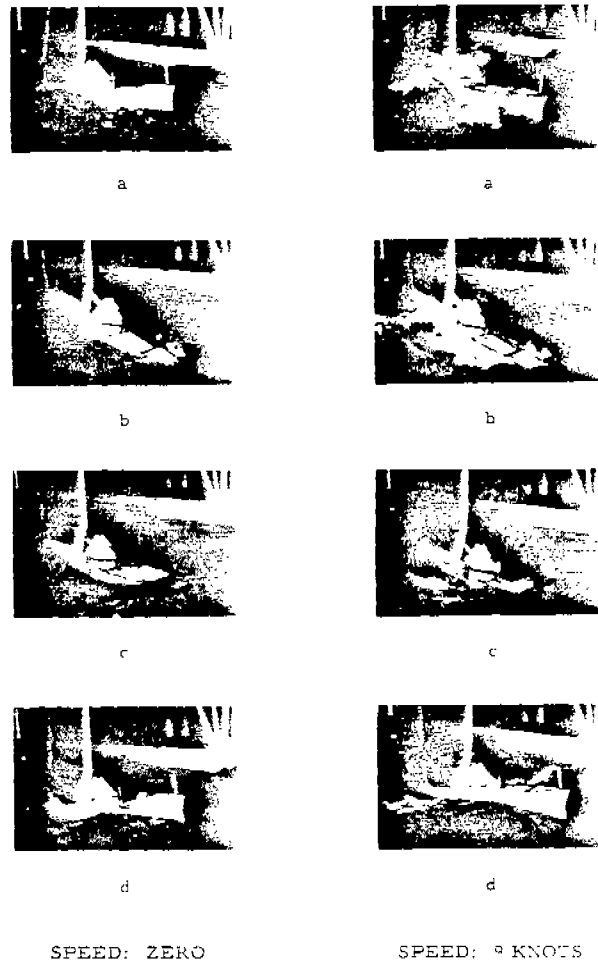

FIG. 1. MARINER (MODEL 2251A-VI)
WAVE LENGTH: 1.25L -- WAVE HEIGHT/
LENGTH: 1/9 HEAD SEAS

shows the model at intervals of about one-fifth the wave encounter cycle in waves of height about equal to one-ninth the wave length. Figure 2 indicates schematically the tank test set-up and the method of towing and restraining the model to motion in a single plane. Figure 3 illustrates the method of connecting the two halves of the model with a moment balance.

The selection of particular ships to model was based on the philosophy that they must represent good current practice in design and be of a type likely to appear in quantity in the future. Three investigations involving changes in model parameters were carried out:

1. Variation of weight distribution in one ship type
2. Variation of freeboard in the same ship type

- ① HEAVE MAST (CONSTRAINED TO MOVE VERTICALLY BY ROLLERS IN SUBCARRIAGE.)
- ② SUBCARRIAGE, FREE IN SURGE. (DOUBLE RAILS RESTRAIN ROLLING MOTION, ABSORB YAW MOMENT AND SWAY FORCE.)
- ③ "NUT CRACKER" (YAW RESTRAINING ARMS TO HOLD HEAVE MAST.)
- ④ TWO AUXILIARY RAILS (PROVIDE SWAY, YAW AND ROLL RESTRAINT THROUGH SUBCARRIAGE.)
- ⑤ BALL CHAIN LOOP (ACTIVATES TRANSDUCER WHICH MEASURES DISPLACEMENT OF SUBCARRIAGE RELATIVE TO MAIN CARRIAGE.)

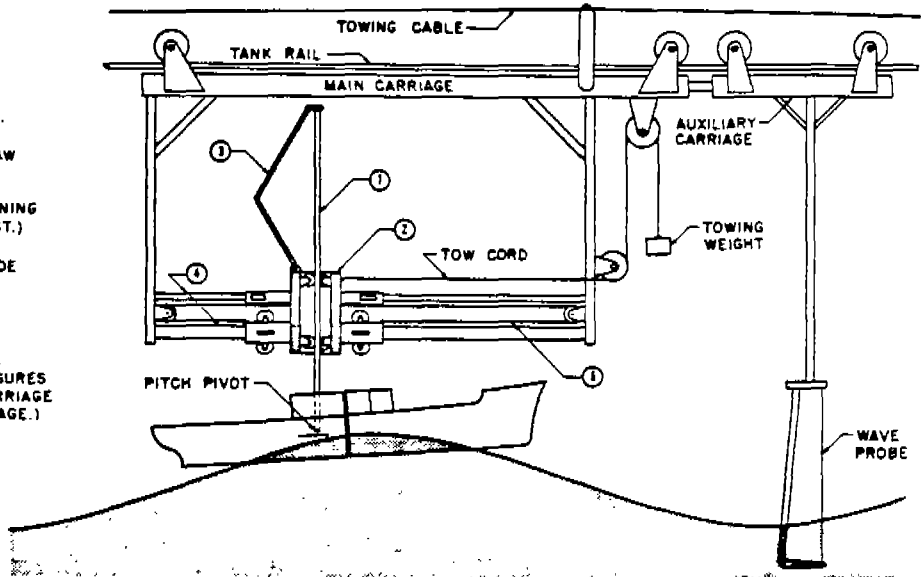

FIG. 2. SCHEMATIC OF TOWING APPARATUS.

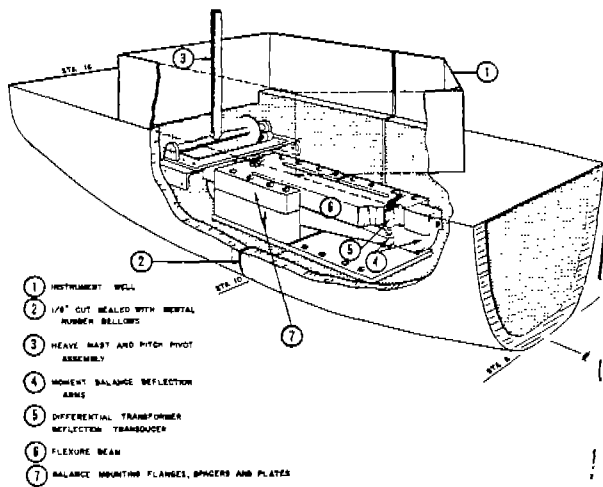

FIG. 3. ARRANGEMENT OF INSTRUMENTATION IN A TYPICAL MODEL.

3. Two additional different ship types for comparison with the first

The first ship type chosen as part of all three investigations was the Mariner, Fig. 4, which well represents current high-speed, dry-cargo ship design. The second ship type was that of a giant tanker, Fig. 5, representative of current trends in bulk carrier design. The third ship type chosen was a destroyer, Fig. 6. Two extreme variations of weight distribution were carried out on the Mariner model, and one variation of freeboard was also carried out on this design, Fig. 7. Table I summarizes the characteristics of all models tested, and fig-

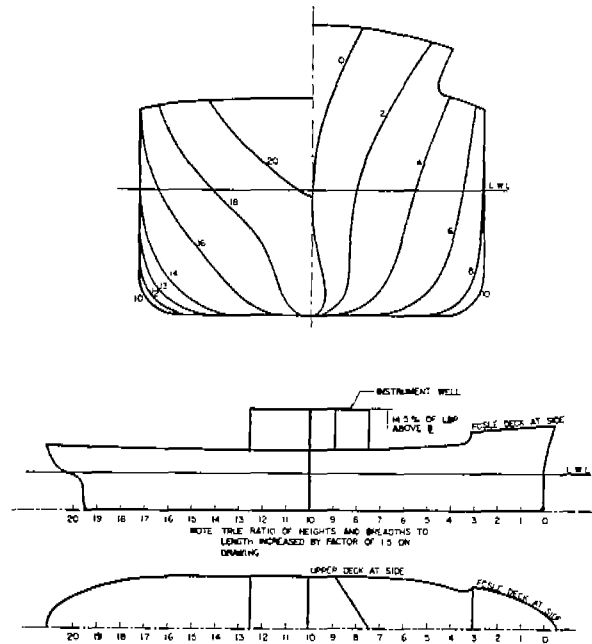

FIG. 4. MODEL DRAWING, BASIC MARINER HULL - MODELS 2251A-VI, 2251A-V2, 2251A-V3.

ures 8a and b show weight distributions employed in the models.

TEST PROGRAM

A preliminary test indicated that fine coverage of all speeds in head and following waves was unnecessary. In addition, the magnitudes of the tow forces involved when the first model was towed at high speed in extreme head waves indicated that the highest practical Froude

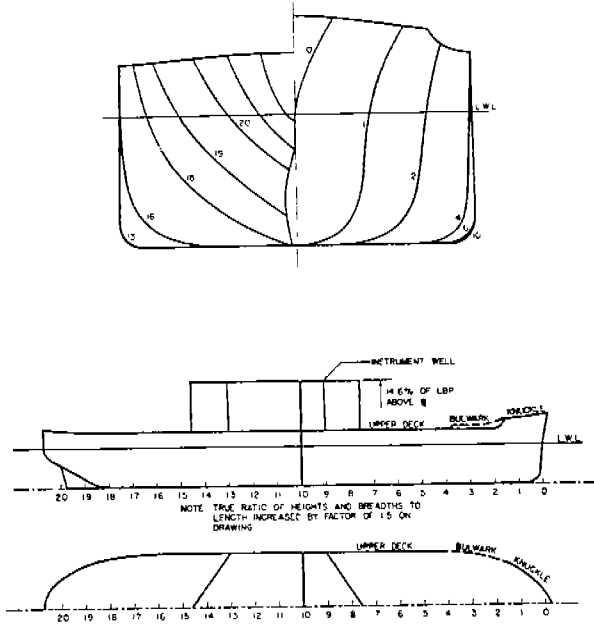

FIG. 5. MODEL DRAWING, MODEL 2251D - GIANT TANKER.

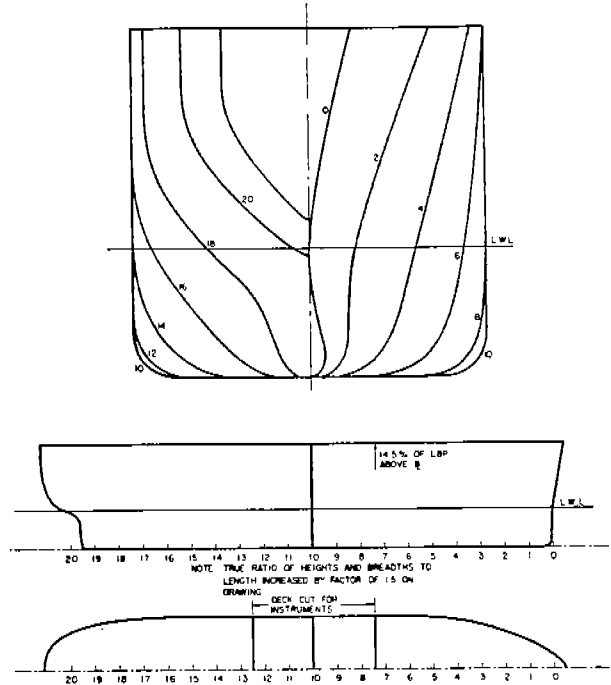

FIG. 7. MODEL DRAWING, MODEL 2251B - MARINER WITH INCREASED FREEBOARD.

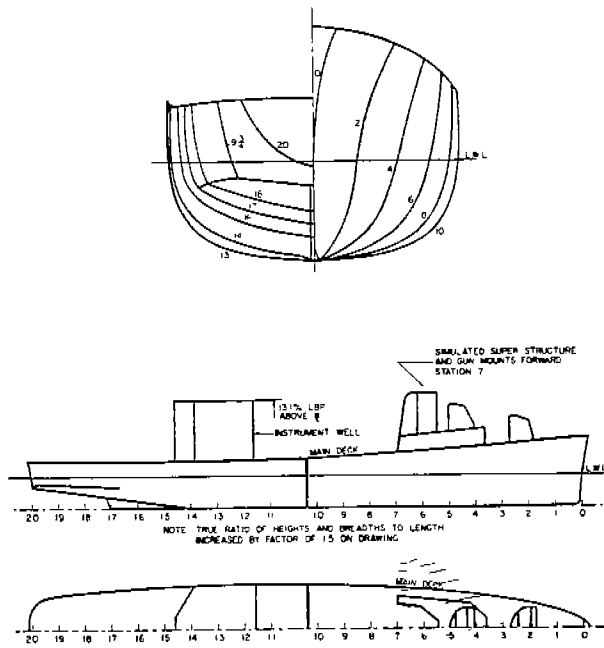

FIG. 6. MODEL DRAWING, MODEL 2130 - DESTROYER.

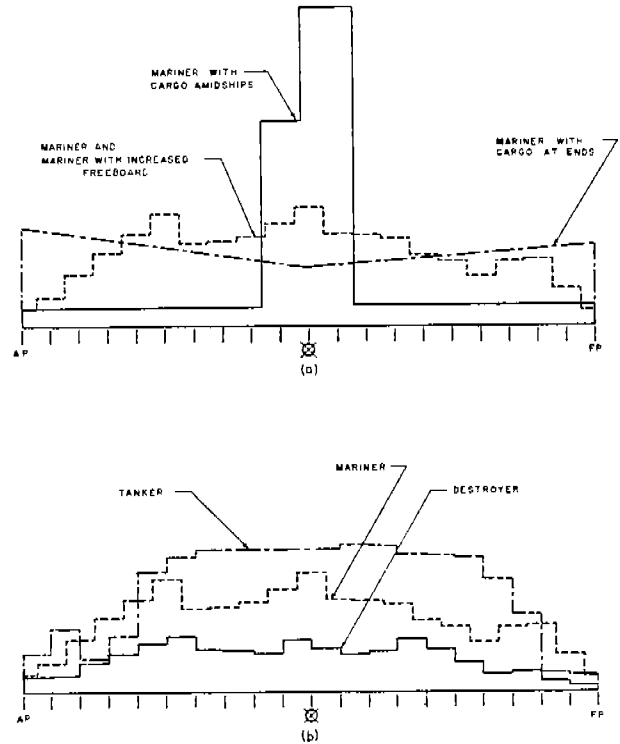

FIG. 8a and b. WEIGHT DISTRIBUTIONS.

TABLE I. MODEL CHARACTERISTICS.

Model Number	2251A-V-1	2251A-V-2	2251A-V-3	2251E	2251D	2130
Design	Mariner	Mariner	Mariner	Mariner With Increased Freeboard	Giant Tanker	Destroyer
Weight Distribution	Design	Cargo \bar{M}	Cargo-Ends	Design	Design	Design
Ship L.B.F., Feet	520.0	520.0	520.0	520.0	695.0	383.0
<u>MODEL CHARACTERISTICS</u>						
Nominal Model Scale	1:104	1:104	1:104	1:104	1:179	1:67.09
Length on 20 Stations, inches	60.00	60.00	60.00	60.00	60.00	68.5
Bear, inches	8.76	8.76	8.76	8.76	8.85	7.30
Draft, inches	3.20	3.20	3.20	3.22	3.28	2.39 Fwd 2.68 Aft
Displacement, Pounds, P.W.	38.1	38.1	38.1	38.1	52.0	25.1
B/H	2.72	2.72	2.72	2.72	2.70	2.92
C _b	0.61	0.61	0.61	0.61	0.80	0.55
C _M	0.98	0.98	0.98	0.98	0.99	-
$\Delta/(L/100)^3$, Design	140	140	140	140	172	62
LCB, % Station Length From \bar{M}	1.42 Aft	1.40 Aft	1.45 Aft	1.44 Aft	0.32 Fwd	3.23 Aft
Gyradius, % Station Length	24.3	15.9	30.3	24.2	22.7	23.4
Natural Pitching Period, Sec.	0.70	0.60	0.80	0.70	0.70	0.60
Natural Heaving Period, Sec.	0.75	0.75	0.80	0.75	0.80	0.65
Natural Frequency of Vibration, CPS	16.5	17.2	14.1	16.5	13.7	10.7
Freeboards: Aft, inches	2.30	2.30	2.30	5.48	1.56	1.37
Fwd, inches	4.05	4.05	4.05	5.48	2.52	3.44
V.C.G., inches	3.34	3.14	3.36	3.39	2.62	1.23
<u>HALF MODEL, FWD SECTION</u>						
Weight, lbs.	17.9	17.9	17.9	17.9	26.6	11.2
LCG Fwd \bar{M} , inches	12.10	6.04	15.88	12.10	11.46	12.88
VCG, inches	3.32	3.46	3.43	3.34	2.60	1.06
K ₀ , % Station Length/2	26.9	24.8	28.2	26.8	23.2	23.9
<u>HALF MODEL, AFT SECTION</u>						
Weight, lbs.	20.2	20.2	20.2	20.2	25.4	13.9
LCG Aft \bar{M} , inches	12.32	6.93	15.72	12.33	11.59	14.56
VCG, inches	3.37	2.86	3.30	3.44	2.65	1.37
K ₀ , % Station Length/2	25.5	21.8	32.0	25.5	25.2	25.6

number would not be in excess of 0.13. The preliminary test also indicated that the situation where the model was drifting helplessly astern under the influence of extreme waves was a practical case worth investigating. There resulted a standard test program for all six models. This program is summarized in Tables II and III. It may be noted from the tables that each model was tested in five speed-heading combinations in waves of five or six different lengths. As full as possible a coverage of wave heights was attempted. In all, approximately 1100 test runs were made, and out of these about 600 runs were selected for analysis.

DATA REDUCTION

Each run resulted in an oscillograph record of midship bending moment, pitch, heave and wave elevation. Because of the steepness of the waves, only a nominal regularity was exhibited in the traces and it was necessary to average the maximum and minimum excursions of a number of cycles to arrive at an estimate

of moment, motion and wave amplitudes. The averaged measurements were suitably non-dimensionalized and grouped according to model, heading, speed and wave length (about 120 groups in all). A mean curve was fitted to each set of test points representing the variation of moment or motion with wave steepness. Figure 9 and Table IV are sample pages for one test group from Ref. 2. All fitted curves were terminated before representing an unreasonable extrapolation of data.

It was found in the initial stages of the analysis that the moments measured at zero speed in head and following seas were nearly enough the same that analysis of the zero-speed following-sea case could be deferred. An analysis of the transient behavior of the moment measuring system was performed and it was concluded that the amplitudes of moment indicated on the records would include little, if any, of the effect of sudden impact.

In order to compress the data, summary

TABLE II. TEST PROGRAM MARINER MODEL AND VARIATIONS.

Model 2251A-V2		Hull as Designed "Cargo" Moved Amidships					
Heading	Speed Classif.	Wave Length/Model Length					
		.50	.75	1.00	1.25	1.50	1.75
180°	Zero		5*	5*	5*	5*	4*
"	Forward		4	5	5*	5	4
"	Drifting		6	6	5*	5	4
0°	Zero			5	5	5	
"	Forward		5	5	5	6	4

Model 2251A-V1		Hull as Designed Design Weight Distribution						Model 2251B		Radical Increase in Freeboard Design Weight Distribution					
Heading	Speed Classif.	Wave Length/Model Length						Heading	Speed Classif.	Wave Length/Model Length					
		.50	.75	1.00	1.25	1.50	1.75			.50	.75	1.00	1.25	1.50	1.75
180°	Zero	4	6*	7*	8*	8*	5*	180°	Zero		4*	5*	5*	5*	4*
"	Forward		4	6	5*	5	6	"	Forward		4	5	5*	5	4
"	Drifting		4	5	5*	5	4	"	Drifting		4	5	5*	6	4
0°	Zero	4	6	6	8	7		0°	Zero			5	5	5	
"	Forward		4	7	5	5	4	"	Forward			3	5	5	

Model 2251A-V3		Hull as Designed "Cargo" Moved to Ends					
Heading	Speed Classif.	Wave Length/Model Length					
		.50	.75	1.00	1.25	1.50	1.75
180°	Zero		4*	5*	6*	5*	4*
"	Forward		4	5	5*	5	4
"	Drifting		4	5	5*	5	4
0°	Zero			5		5	
"	Forward			5		5	

a. Numbers in the blocks indicate the number of good runs obtained in order to cover the range of wave heights. Blanks indicate no runs attempted

b. * Indicates a motion picture record of the model in the highest wave.

TABLE III. TEST PROGRAM GIANT TANKER AND DESTROYER MODELS.

Model 2251D		GIANT TANKER					
Heading	Speed Classif.	Wave Length/Model Length					
		.50	.75	1.00	1.25	1.50	1.75
180°	Zero	4	5*	6*	6*	6*	4*
"	Forward	4	4	5	5*	5	4
"	Drifting		4	5	5*	5	4
0°	Zero			5	5	5	
"	Forward			5	5	5	

Model 2130		DESTROYER					
Heading	Speed Classif.	Wave Length/Model Length					
		.50	.75	1.00	1.25	1.50	1.75
180°	Zero		4*	5*	5*	5*	4*
"	Forward		4	5	5*	5	4
"	Drifting		4	5	5*	5	4
0°	Zero			5	5	5	
"	Forward			5	5	5	

a. Numbers in the blocks indicate the number of good runs obtained in order to cover the range of wave height. Blanks indicate no runs attempted.

b. * Indicates a motion picture record of the model in the highest wave.

plots of the faired lines for moments and motions for each model, heading and speed were prepared. Figure 10 is a typical bending moment vs. wave steepness plot, one of 24 such plots appearing in Refs. 2 and 3. All bending amplitudes are referred to the midship moment existing in the model afloat in calm water; that is, wave bending moments only. The scale on the right of Fig. 10 is compensated for the still-water moment for illustrative purposes.

A. Differences Between Models

While not a primary objective, a measure of the variation in bending moments from model to model was obtained and exhibited in the form of cross plots, examples of which are shown in Figs. 11 and 12. (Moments for specific steepnesses plotted on a base of wave length.) One finding in the analysis of differences between models was that a particularly important model variable is the average moment of model weight about amidships. This influences wave bending moments because it appears to be the major model variable in the component of moment produced by pitch and heave accelerations. The

MODEL 2251A-VI TEST GROUP I-1122125
 WAVE LENGTH: 1.25 L MODEL HEADING: 180°
 APPROX MODEL SPEED: $v/\sqrt{gL} = 0.12$ to 0.14

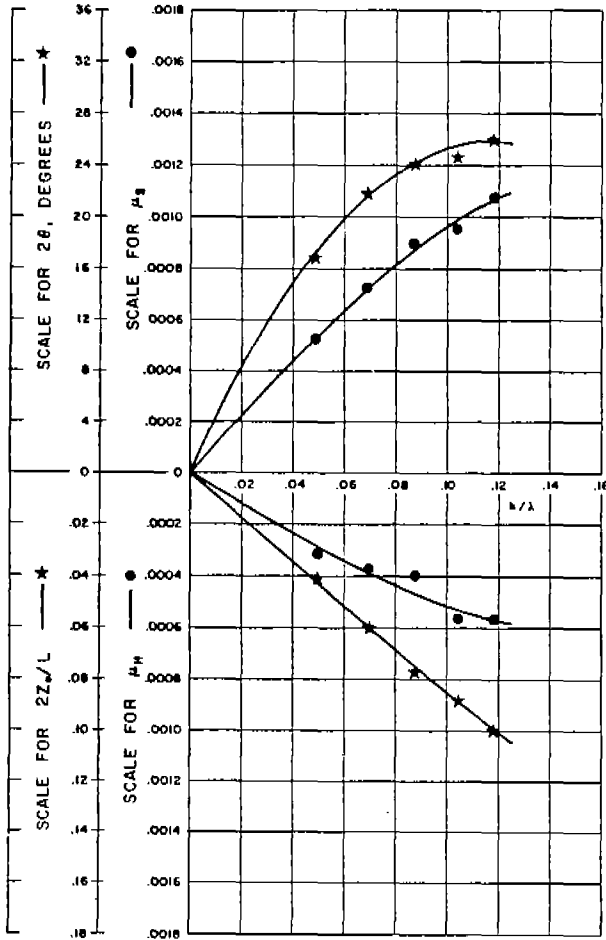

FIG. 9. SAMPLE TEST RESULTS.

net bending moment is considered to be the algebraic sum of the integrated hydrodynamic pressures on the hull (here termed "hydrodynamic moments") and the internal reactions resulting from the acceleration of the model. The signs of these components are opposite and thus if the hydrodynamic moment remains constant, a greater mass acceleration moment may result in a smaller net bending moment. The test results supported the hypothesis that hydrodynamic moments were roughly constant since wave bending moments decreased as weight was concentrated more towards the ends of the model. (Unfortunately, such action adversely affected the seakindliness of the model.) Conversely, when weight was moved toward amidships, moments increased (and seakindliness was improved). Figure 12 shows the net bending moments and the derived "hydrodynamic" moments for the four Mariner-

MODEL 2251A-VI, MARINER, PARENT
 MODEL HEADING: 180°, HEAD SEAS
 APPROX. MODEL SPEED: $v/\sqrt{gL} = 0.0$

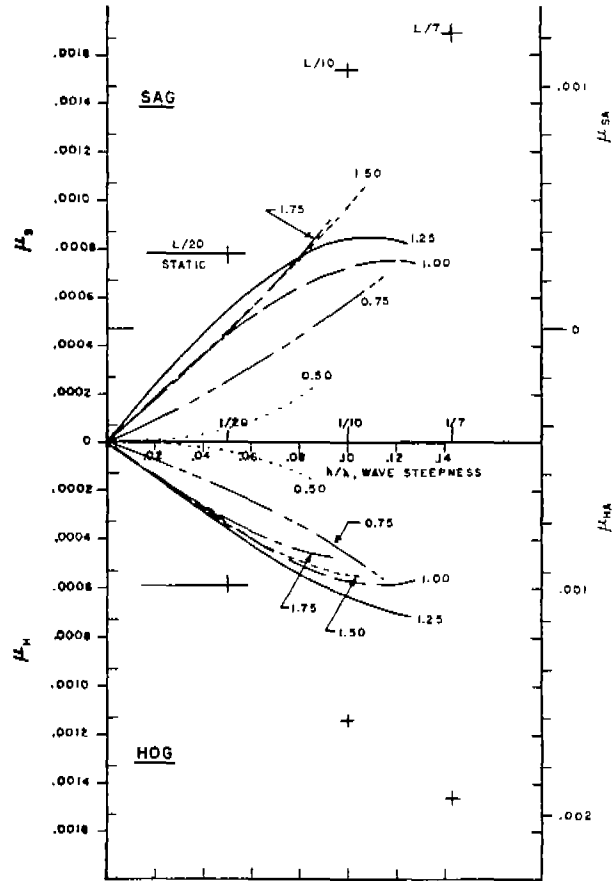

FIG. 10. SAMPLE FAIRED LINE SUMMARY.

type variations. It demonstrates by virtue of the "collapse" of the hydrodynamic moments that the primary source of the differences between net moments measured in the weight distribution investigation was the mass acceleration moment.

Some difference in moments was observed when freeboard was increased. Sagging moments were observed to increase with an increase in freeboard.

It was observed that bending moments for the three basic ship types increased about in order of fullness. Very large wave hogging moments were experienced by the Tanker model.

TABLE IV. SAMPLE TEST RESULT TABULATION.

Model: <u>2251A-V1 - Mariner, Parent</u>			Test Group: <u>1.1122125</u>		
Zero Wave Bending Moment Corresponds to a Still Water Moment of: <u>0.00047 HOG</u>			Wave Length: <u>1.25L</u>		
1.0L Static Calculations (Non-Dimensional)			Heading: <u>180</u> Degrees		
Wave Height	Wave Sag	Wave Hog	Speed: <u>0.12 to 0.14</u>		
<u>L/20</u>	<u>0.00078</u>	<u>0.00059</u>	Heave Tuning Factor: <u>0.90</u>		
<u>L/10</u>	<u>0.00154</u>	<u>0.00114</u>	Pitch Tuning Factor: <u>0.85</u>		
Bow-up-Pitch Lags Sagging Moment Approx.:			<u>125</u>	Degrees	
Up-Heave Lags Sagging Moment Approx.:			<u>205</u>	Degrees	
Coefficients of Equation Fitted to Run Averages of Amplitude					
Y =	μ_s	μ_H	2θ	$2Z_0/L$	
N	<u>3</u>	<u>2</u>	<u>2</u>	<u>4</u>	
a	<u>.0110</u>	<u>.00641</u>	<u>440.</u>	<u>.876</u>	
b	<u>-.144</u>	<u>-.0128</u>	<u>-1897.</u>	<u>-17.9</u>	
RMS Deviations of Measured Amplitudes within Each Run (Units consistent with those on plot)					
Run No.	<u>248</u>	<u>255</u>	<u>257</u>	<u>219</u>	<u>218</u>
h/λ	<u>.0493</u>	<u>.0690</u>	<u>.0865</u>	<u>.104</u>	<u>.118</u>
No. Cycles	<u>20</u>	<u>20</u>	<u>20</u>	<u>14</u>	<u>15</u>
rms Wave x 10 ²	<u>.28</u>	<u>.43</u>	<u>.37</u>	<u>.63</u>	<u>.51</u>
rms Sag x 10 ⁴	<u>.31</u>	<u>.16</u>	<u>.21</u>	<u>.32</u>	<u>.68</u>
rms Hog x 10 ⁴	<u>.23</u>	<u>.12</u>	<u>.25</u>	<u>.31</u>	<u>.79</u>
rms Pitch, deg.	<u>.73</u>	<u>.57</u>	<u>.55</u>	<u>.80</u>	<u>1.20</u>
rms Heave x 10 ²	<u>.46</u>	<u>.28</u>	<u>.26</u>	<u>.53</u>	<u>.40</u>
REMARKS: (1) Form of Equation: $Y = a(h/\lambda) + b(h/\lambda)^N$					
(2) Sagging moments in waves above $h/\lambda = .07$ increased by forward bottom impacts. Pulse duration believed long enough for amplitude resolution within 10%.					

B. Trends of Bending Moments With Wave Steepness.

Since it was very difficult to generalize about trends of moment with wave steepness on the basis of the 24 plots similar to Fig. 10, a numerical criterion defining the shape of the fitted lines was derived. A graphical illustration of this criterion is shown in Fig. 13. The families of curves plotted illustrate the shape of the curves for various values of the criterion γ . Because the criterion was dependent on the form of the equation fitted to the test points, families of curves are shown for the two most widely different equations used. The γ

criterion was calculated for all test conditions and the results were grouped as follows:

- Class (++) $\gamma > +.15$
- Class (+) $+.15 > \gamma > +.05$
- Class (0) $+.05 > \gamma > -.05$
- Class (-) $-.05 > \gamma > -.15$
- Class (--) $-.15 > \gamma$

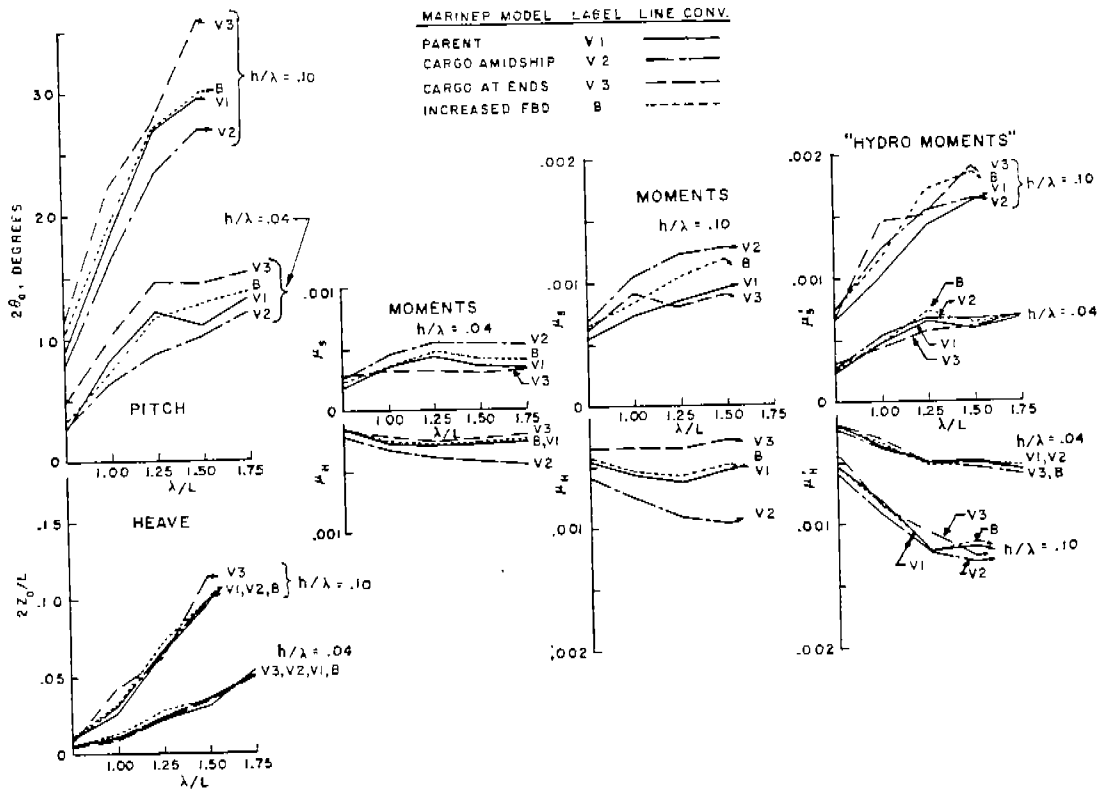

FIG. 11. CROSS PLOT OF FAIRED MOMENTS AND MOTIONS HEAD SEAS FROUDE NO. 0.0.

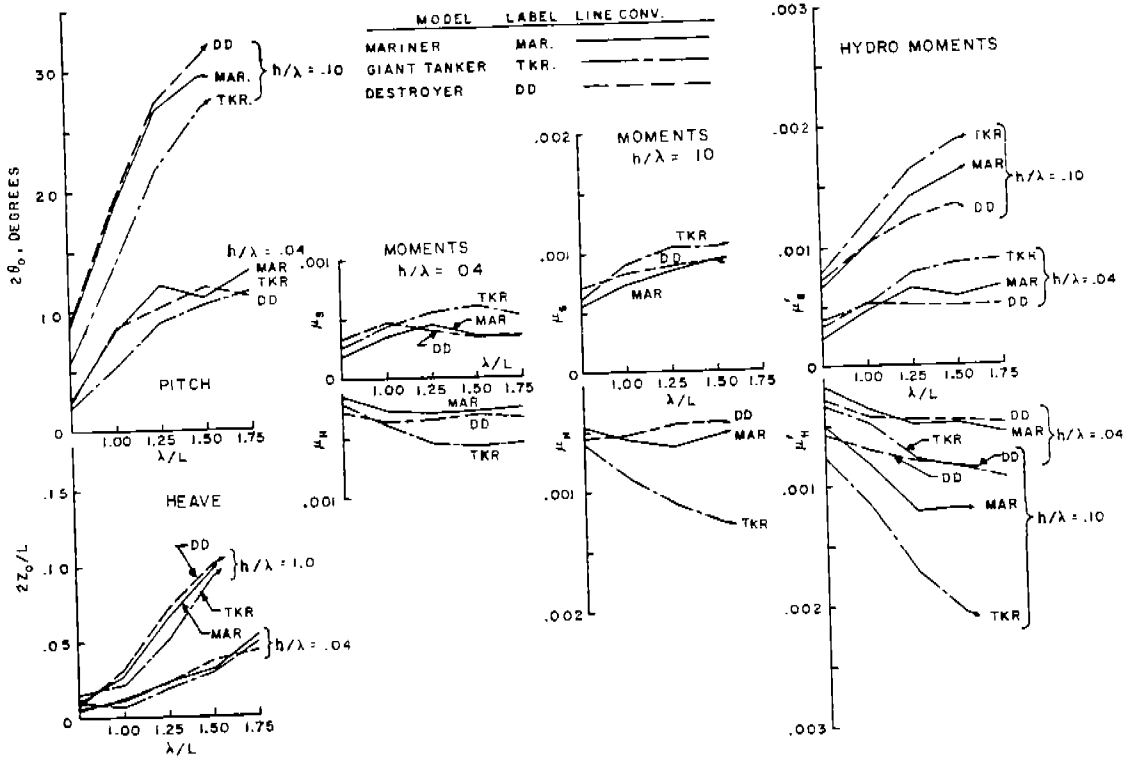

FIG. 12. CROSS PLOT OF FAIRED MOMENTS AND MOTIONS HEAD SEAS FROUDE NO. 0.0.

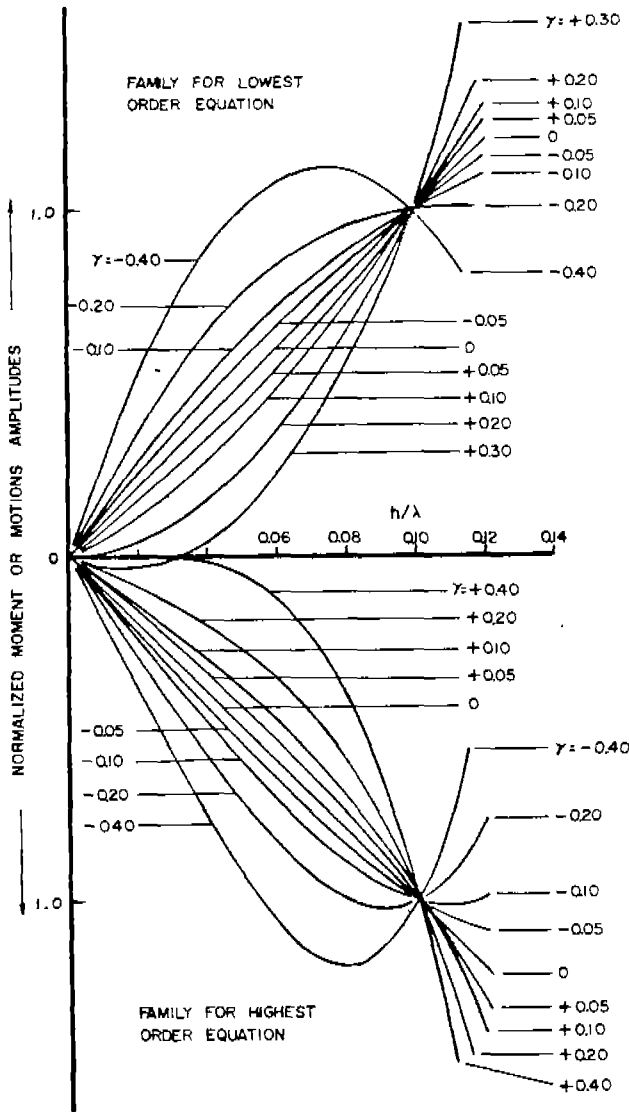

FIG. 13. EXAMPLES: NUMERICAL CLASSIFICATION OF FITTED CURVES.

These groups can be interpreted as follows:

1. Class (++) and (+): No limiting bending moment indicated by data.
2. Class (0): Data indicates only small departure from straight line.
3. Class (-): Data indicates limiting moment above a steepness of 1/9.
4. Class (--): Data indicates limiting moment below wave steepness of 1/9.

Tabulated results of the classification of trends are shown in Tables V, VI, and VII. The primary conclusions of the study were drawn from these tables.

It was noted that the magnitudes of moments were about the same for all the speed conditions except head-sea forward-speed, and that the highest moments occurred in the longest waves. Thus for speed conditions other than head-sea forward-speed, it was necessary to have Class (--) in almost all of the blocks pertaining to the longer waves for a model in order to conclude that a limiting moment was to be expected in wave steepnesses less than 1/9. This was true in only one case, that of the destroyer hogging moments. In all other cases such limits as exist are indicated for wave steepnesses of 1/9 and much higher.

It was felt that the head-sea forward-speed case could be eliminated for practical reasons so that the trends in this case were not considered in the formulation of conclusions. However, if the trends for this speed case had been considered where moment magnitudes exceeded those obtained in the other speed cases, no essential differences in the conclusions would have resulted except that the lower limit for destroyer hogging moments might not have been cited.

The practical basis of these conclusions hinges on the trend of the moments measured in the most severe wave lengths. Limiting trends displayed in other wave lengths may have little practical significance. In order to help confirm the conclusions obtained, a fresh start on the analysis was made without benefit of fitted lines or numerical manipulation. Every test point obtained in any wave condition and at all of the four speeds was plotted on a single chart for each model. (Figs. 14 to 19). The only differentiation between points which was made was between those for the impractical head-sea forward-speed case (solid circles) and those for all other speeds (open circles).

Envelopes to the scatter of points were drawn up to a wave steepness of 0.10, excluding the points for the head-sea forward-speed case. The envelopes were terminated at $h/\lambda = 0.10$ because the long wave lengths which contribute many of the highest moments are not well represented beyond this point. These envelopes were superimposed in Fig. 20. It can be seen that with the exception of the destroyer hogging moments, the envelopes of all moments measured at practical speeds in all models imply no limit at a wave steepness less than 1/9 and most imply no limit below the

TABLE V. CLASSIFICATION OF TRENDS WITH WAVE STEEPNESS OF MOMENT AND MOTIONS. WEIGHT DISTRIBUTION INVESTIGATION.

Speed, Heading	λ/L	Sagging Moment		Hogging Moment		Pitch		Heave		Hydro. Sag		Hydro. Hog				
		Cargo Amidship	Parent	Cargo at Ends	Cargo Amidship	Parent	Cargo at Ends	Cargo Amidship	Parent	Cargo at Ends	Cargo Amidship	Parent	Cargo at Ends	Cargo Amidship	Parent	Cargo at Ends
0.12 to 0.14, 180°	0.75	-	+	+	-	+	0	-	+	-	+	0	-	+	0	
	1.00	-	0*	0*	-	0	+	0	-	-	0*	-	-	0	0	
	1.25	-	0*	0*	-	0	0*	+	-	-	0	0*	-	0	0*	
	1.50	0	0*	0*	-	0	+	0	-	-	0	+	0	0	+	
0.0, 180°	0.75	0	0	-	0	+	0	0	+	0	-	0	0	0	0	
	1.00	0	-	0*	0	-	-	0	-	-	0	0	+	0	0	
	1.25	-	0	0*	0	-	-	0	0	0	0	0*	0	0	0	
	1.50	0	0	+	0	-	-	0	0	0	0	+	0	0	0	
-0.08 to -0.15, 180°	0.75	-	+	0	0	0	0	+	+	0	0	+	0	0	0	
	1.00	0	0	0	0	0	0	0	0	0	+	0	0	0	0	
	1.25	+	0	0	+	0	0	0	0	0	+	0	0	+	0	
	1.50	0	0	-	0	0	0	0	0	0	+	0	0	0	0	
0.16 to 0.26, 0°	1.00	0	0	0	0	0	0	0	+	0	0	0	0	0	0	
	1.25	0	0	ND	+	+	ND	0	0	ND	0	0	ND	+	+	ND
	1.50	+	+	0	+	+	+	-	0	0	+	+	0	+	ND	+

NOTATION
 * Trace Distorted by Impact
 ND-No Data

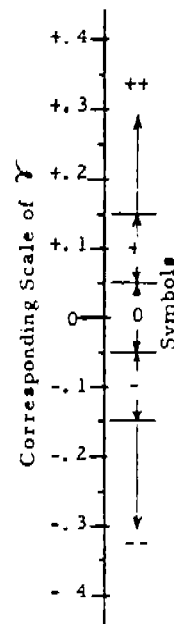

theoretical limit of stability (1/7).

It is interesting to compare these results with those of Ref. 4.. The experimental work of Ref. 4 was quite different from that reported herein in that it dealt with irregular model seas. It was similar in two important respects:

1. The model utilized was the same destroyer model used herein.
2. The severity of the irregular waves of Ref. 4 was comparable to the severity of the regular waves of this study.

As in the present results, those of Ref. 4 imply that midship bending moment ranges are roughly proportional to wave steepness over a very large range of steepness. (No distinction could be made in Ref. 4 between hogging and sagging moment trends). It is therefore considered likely that the trends of bending moment with wave steepness shown herein approximate those expected for significant bending moment amplitudes in random seas of increas-

ing severity.

CONCLUSIONS

1. It appears on the basis of these studies that design wave bending moments are essentially proportional to wave heights which actually may be encountered.
2. The present study, by establishing more firmly the grossly linear dependence of moments on wave heights over a considerable range of wave severity, has strengthened the case for determining design moments on the basis of statistical analyses of sea waves and/or the resulting moments.
3. Within practical operational and design limits for ships at either end of the cargo carrying spectrum, no significant limit on midship wave bending moments in head or following waves is to be expected as wave steepness is increased up to a value of about 1/9. The same result is obtained for the sagging moments ex-

TABLE VI. CLASSIFICATION OF TRENDS WITH WAVE STEEPNESS OF MOMENT AND MOTIONS. FREEBOARD INVESTIGATION.

Speed, Heading	λ/L	Sagging Moment		Hogging Moment		Pitch		Heave		Hydro. Sag		Hydro. Hog	
		Parent	Increased Freeboard	Parent	Increased Freeboard	Parent	Increased Freeboard	Parent	Increased Freeboard	Parent	Increased Freeboard	Parent	Increased Freeboard
0.12 to 0.14, 180°	0.75	+	+	-	-	-	-	-	-	0	+	-	0
	1.00	0*	0*	0	0	0	0	0	0	0*	0*	0	0
	1.25	0*	0*	0	0	0	0	0	+	0*	0*	0	0
	1.50	0*	0*	0	0	0	0	0	+	0*	0*	0	0
0.0, 180°	0.75	0	0	+	0	+	+	-	0	0	0	0	0
	1.00	0	0	0	0	0	0	0	+	0	0	0	0
	1.25	0	0	0	0	0	0	0	0	0	0	0	0
	1.50	0	0	0	0	0	0	0	0	0	0	0	0
-0.06 to -0.15, 180°	0.75	+	+	0	0	+	+	-	0	+	0	0	0
	1.00	0	0	0	0	0	0	0	+	0	0	0	0
	1.25	0	0	0	0	0	0	0	0	0	0	0	0
	1.50	0	0	0	0	0	0	0	0	0	0	0	0
0.16 to 0.20, 0°	1.00	0	+	0	0	0	+	0	+	0	+	0	0
	1.25	+	+	+	+	0	0	0	0	0	+	+	+
	1.50	+	+	+	+	0	+	+	+	ND	0	ND	+

NOTATION

* Trace Distorted by Impact
 ND - No Data

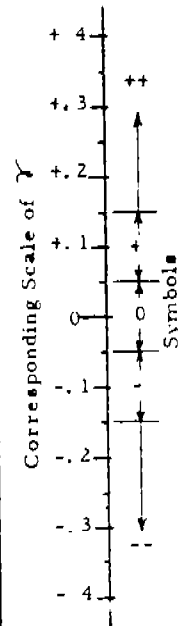

perienced by the naval type but not for the hogging moments; in which case an upper wave hogging moment limit is suggested at a wave steepness of about 1/9.

RECOMMENDATIONS

The present study involved itself only with midship bending moments for reasons of economy, even though it was known that under certain conditions higher wave bending moments may develop elsewhere along the ship length. It is considered of importance to ascertain if the conclusions of this study pertaining to commercial ship types also hold for moments all along the length of the ship. If similar conclusions can be drawn for moments elsewhere along the length of the ship, no further development of this type of experiment would be recommended.

REFERENCES

1. Lewis, E. V. and Gerard, G.: "A Long-Range Research Program in Ship Structural Design," Ship Structure Committee, Serial SSC-124, November 1959.
2. Dalzell, J. F.: "An Investigation of Midship Bending Moments Experienced in Extreme Regular Waves by Models of the Mariner Type Ship and Three Variants," To be published by Office of Technical Services as PB-181508.
3. Dalzell, J. F.: "An Investigation of Midship Bending Moments Experienced in Extreme Regular Waves by Models of a Tanker and a Destroyer," To be published by OTS as PB-181509.

TABLE VII. CLASSIFICATION OF TRENDS WITH WAVE STEEPNESS OF MOMENT AND MOTIONS. SHIP TYPE INVESTIGATION.

Speed, Heading	γL	Sagging Moment			Hogging Moment			Pitch			Heave			Hydro. Sag			Hydro. Hog		
		Giant Tanker	Mariner	Destroyer	Giant Tanker	Mariner	Destroyer	Giant Tanker	Mariner	Destroyer	Giant Tanker	Mariner	Destroyer	Giant Tanker	Mariner	Destroyer	Giant Tanker	Mariner	Destroyer
0.12 to 0.14, 180°	0.75	-	+	0	-	+	-	-	0	0	-	-	0	0	0	-	-	-	
	1.00	-*	0*	0*	-*	0*	+	0	-	-	0	-	+	-*	-*	0*	-*	-*	
	1.25	-*	0*	0*	-*	0*	+	-	-	0	0	+	0*	0*	0*	0*	0	+	
	1.75	-*	+	0	-*	-	-	-	0	0	0	0	+	+	0	0	0	0	
0.0, 180°	0.75	0	0	-	0	+	-	+	+	+	+	+	0	0	0	0	0	-	
	1.00	-	-	-	0	-	-	0	+	0	0	+	0	-	-	0	0	-	
	1.25	-	0	0	-	-	-	0	-	0	0	+	0	0	0	0	0	-	
	1.50	-	0	0	0	-	-	0	0	0	0	+	+	0	0	0	0	-	
-0.08 to -0.15, 180°	0.75	0	+	-	0	0	0	0	+	+	0	-	0	+	-	0	0	0	
	1.00	0	0	0	0	0	0	0	0	0	0	+	0	0	0	0	0	-	
	1.25	-	0	0	0	0	-	0	0	0	+	0	+	-	0	0	0	-	
	1.50	-	0	-	-	0	-	0	0	0	0	0	0	-	0	-	0	-	
0.16 to 0.26, 0°	1.00	0	0	0	0	0	-	0	0	0	0	0	+	0	0	0	0	0	
	1.25	-	0	0	0	+	-	0	0	0	+	0	+	-	0	0	0	+	
	1.50	-	+	0	0	+	-	0	0	0	+	+	0	-	ND	0	0	ND	

NOTATION

*Trace Distorted by Impact
ND-No Data

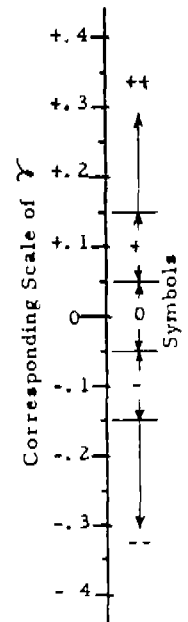

4. Dalzell, J. F.: "Some Further Experiments on the Application of Linear Superposition Techniques to the Responses of a Destroyer Model in Extreme Irregular Long-Crested Head Seas," DL Report 918, September 1962.

NOMENCLATURE

B	Maximum model beam	L	Model length on 20 stations
g	Acceleration due to gravity	LBP	Length between perpendiculars
H	Draft	LCG	Longitudinal center of gravity
h	Wave height	\overline{M}_{FA}	Average midship bending moment due to acceleration of model mass
λ	Wave length	\overline{M}_{RE}	Part of \overline{M}_{FA} in phase with measured bending moments
h/λ	Wave steepness		

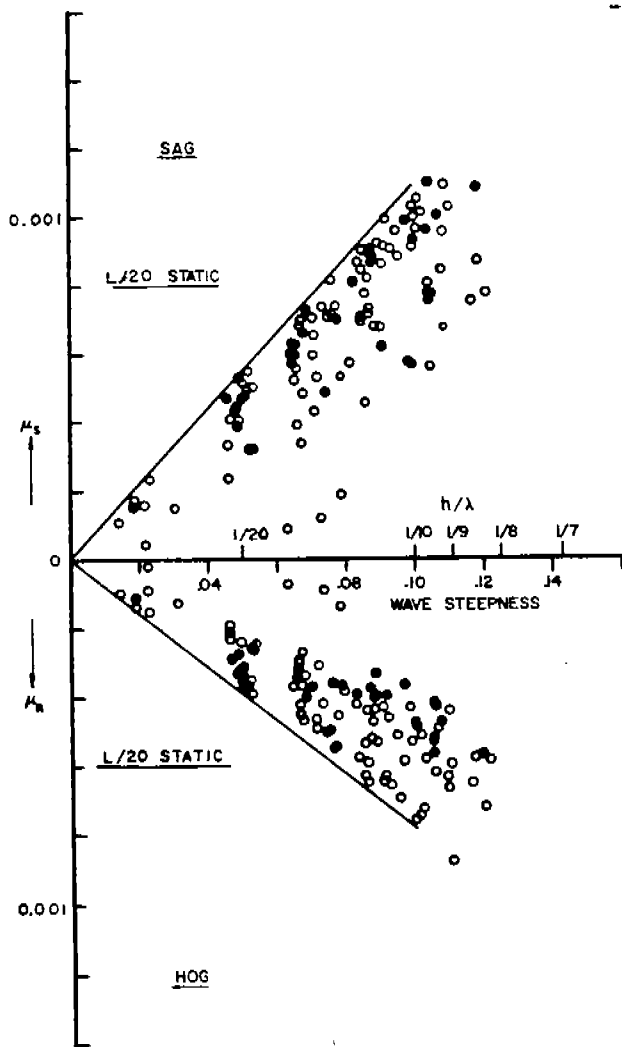

FIG. 14. MEASURED BENDING MOMENT DATA
 ---- ALL WAVE LENGTHS AND SPEEDS. MODEL
 2251A-VI; PARENT MARINER.

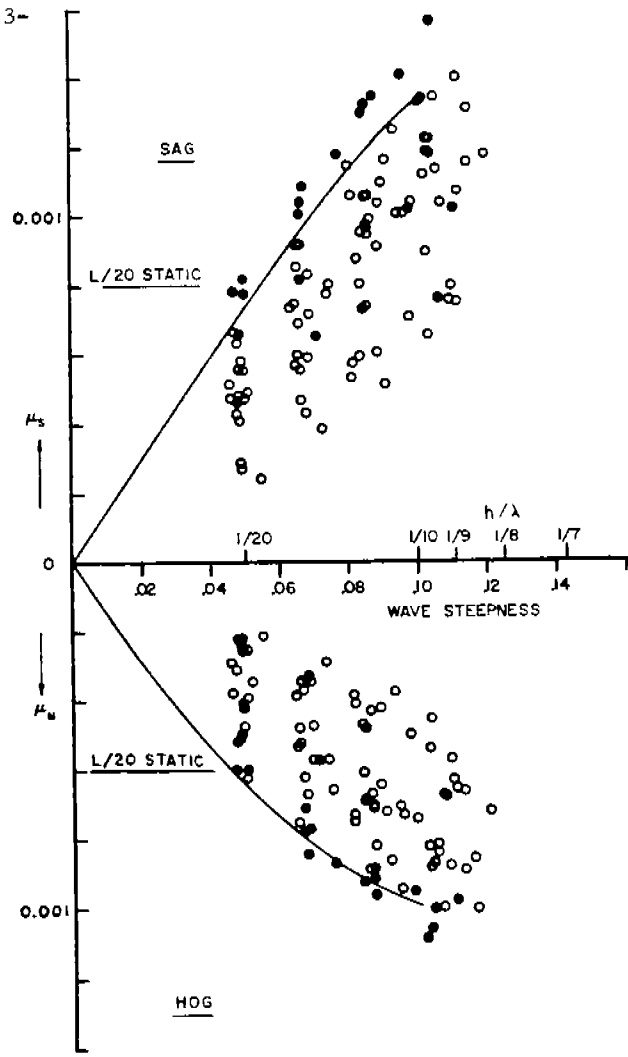

FIG. 15. MEASURED BENDING MOMENT DATA
 ---- ALL WAVE LENGTHS AND SPEEDS MODEL
 2251A-V2; MARINER, CARGO AMIDSHIP.

$2Z_o/L$ Non-dimensional heave double amplitude

γ Quantity derived in the numerical classification of trends

$2\theta_o$ Pitch double amplitude

λ/L Wave length to model length ratio

μ_H Wave hogging moment coefficient (hogging moment/ $\rho g L^3 B$)

μ_S Wave sagging moment coefficient (sagging moment/ $\rho g L^3 B$)

μ_H^i Approximate hydrodynamic wave hogging moment ($\mu_H - \bar{M}_{RE}$)

μ_S^i Approximate hydrodynamic wave sagging moment ($\mu_S - \bar{M}_{RE}$)

μ_{HA} Total hogging moment, wave moment corrected for still-water moment

μ_{SA} Total sagging moment, wave moment corrected for still-water moment

ρ Mass density of water

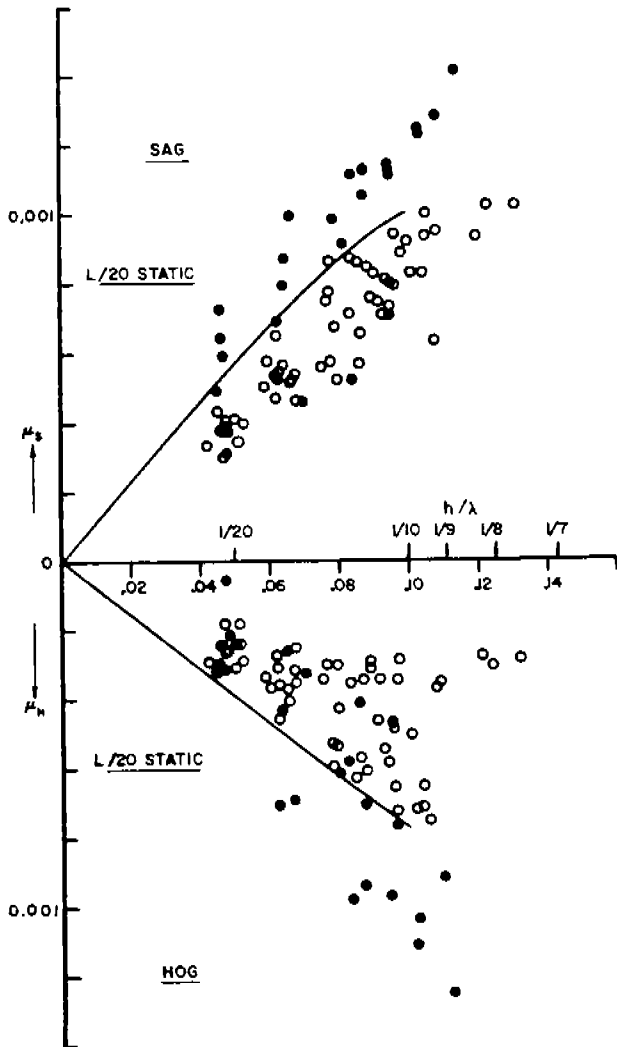

FIG. 16. MEASURED BENDING MOMENT DATA
---- ALL WAVE LENGTHS AND SPEEDS MODEL
2251A-V3; MARINER, CARGO AT ENDS.

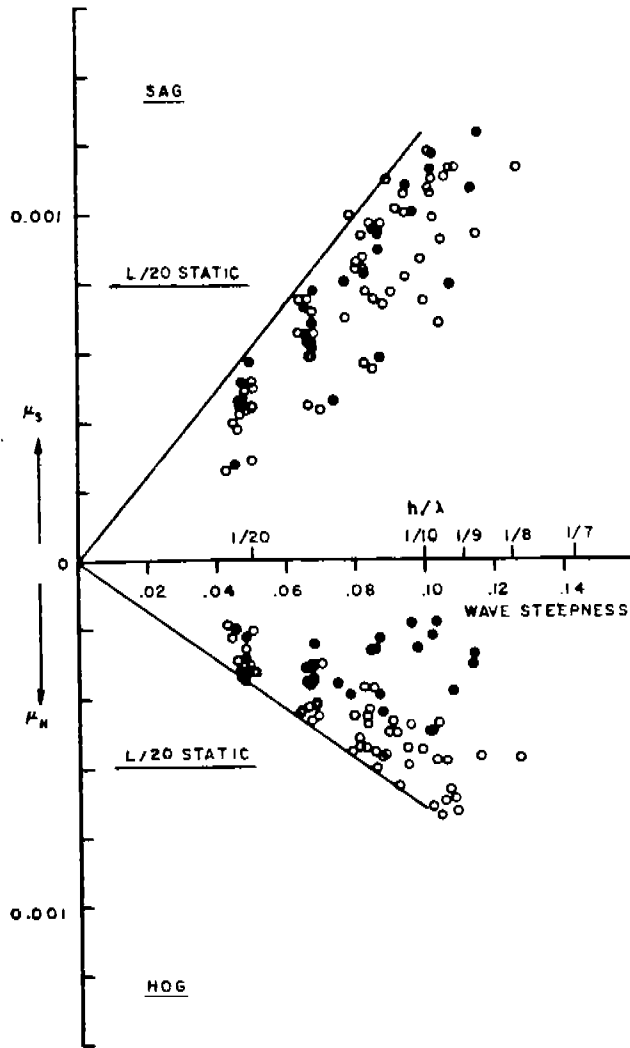
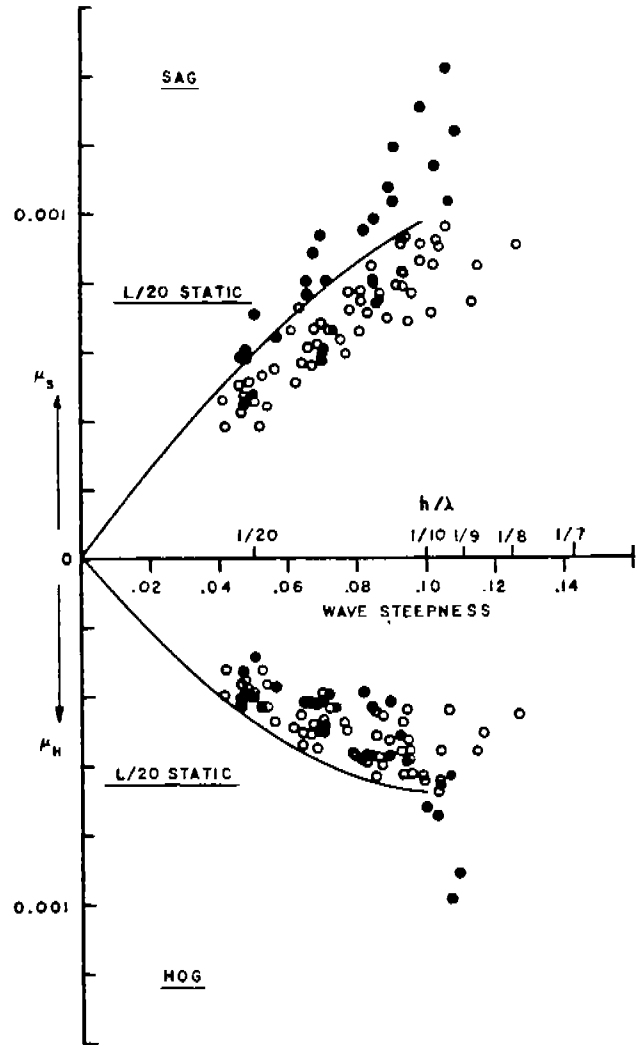
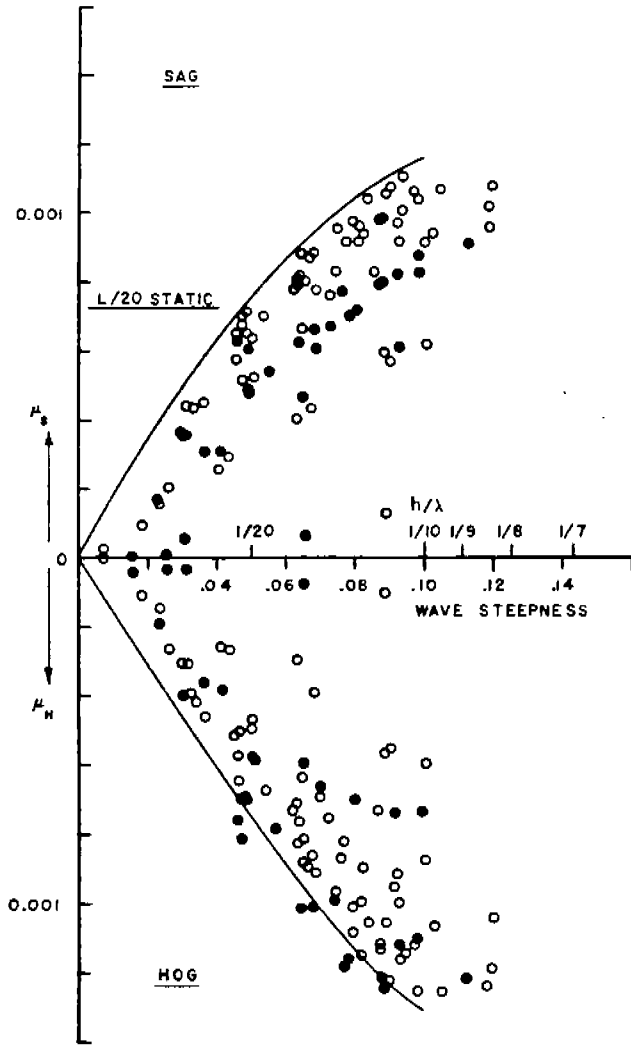

FIG. 17. MEASURED BENDING MOMENT DATA
---- ALL WAVE LENGTHS AND SPEEDS MODEL
2251B; MARINER, INCREASED FREEBOARD.



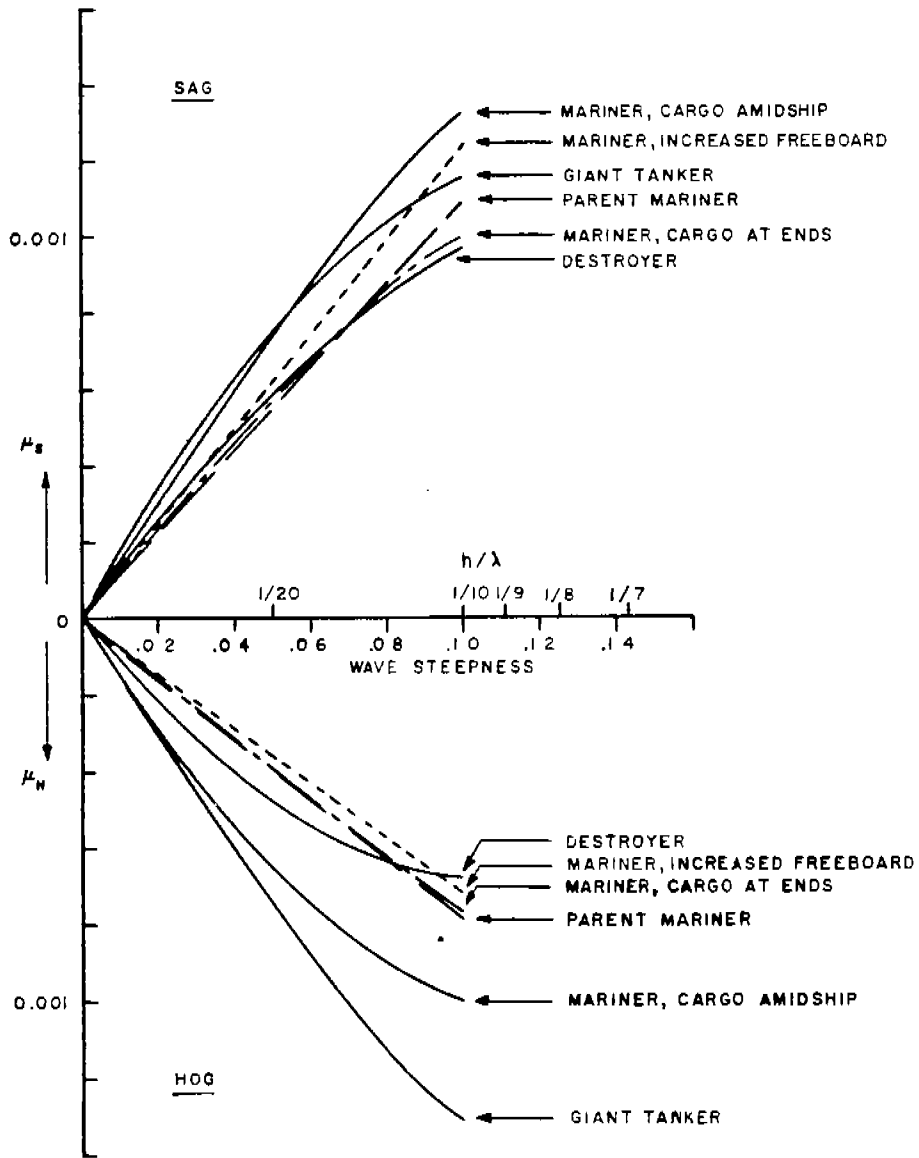

FIG. 20. ENVELOPES OF MEASURED BENDING MOMENT DATA FOR SIX MODELS AT ZERO AND NEGATIVE FORWARD SPEED IN HEAD WAVES AND AT HIGH FORWARD SPEED IN FOLLOWING WAVES.

NAS
1942

SHIP HULL RESEARCH COMMITTEE

Division of Engineering & Industrial Research
~~National Academy of Sciences~~-National Research Council

Chairman:

A. G. Mumma
Vice President
Worthington Corporation

Members:

Hollinshead de Luce
Shipbuilding Division
Bethlehem Steel Co.

J. Harvey Evans
Professor of Naval Architecture
Massachusetts Institute of Technology

M. G. Forrest
Vice President, Naval Architecture
Gibbs & Cox, Inc.

James Goodrich
Vice President and General Manager
Todd Shipyards, Los Angeles Div.

N. J. Hoff
Head, Dept. of Aeronautics & Astronautics
Stanford University

M. W. Lightner
Vice President, Applied Research
U. S. Steel Corporation

I. R. Low, Jr.
Metallurgy & Ceramics Research Dept.
General Electric Research Laboratory

Arthur R. Lytle
Director

R. W. Rumke
Executive Secretary